

# 128K x 8 High-Speed CMOS EPROM

**Features**

- CMOS for optimum speed/power
- High speed
  - $t_{AA} = 25$  ns max. (commercial)
  - $t_{AA} = 35$  ns max. (military)
- Low power
  - 275 mW max.
  - Less than 85 mW when deselected
- Byte-wide memory organization
- 100% reprogrammable in the windowed package
- EPROM technology
- Capable of withstanding >2001V static discharge
- Available in
  - 32-pin PLCC
  - 32-pin TSOP-I
  - 32-pin, 600-mil plastic or hermetic DIP
  - 32-pin hermetic LCC

**Functional Description**

The CY27H010 is a high-performance, 1-megabit CMOS EPROM organized in 128 Kbytes. It is available in industry-standard 32-pin, 600-mil DIP, LCC, PLCC, and TSOP-I packages. These devices offer high-density storage combined with 40-MHz performance. The CY27H010 is available in windowed and opaque packages. Windowed packages allow the device to be erased with UV light for 100% reprogrammability.

The CY27H010 is equipped with a power-down chip enable ( $\overline{CE}$ ) input and output enable ( $\overline{OE}$ ). When  $\overline{CE}$  is deasserted, the device powers down to a low-power standby mode. The  $\overline{OE}$  pin three-states the outputs without putting the device into standby mode. While  $\overline{CE}$  offers lower power,  $\overline{OE}$  provides a more rapid transition to and from three-stated outputs.

The memory cells utilize proven EPROM floating-gate technology and byte-wide intelligent programming algorithms. The EPROM cell requires only 12.75 V for the supervoltage and low programming current allows for gang programming. The device allows for each memory location to be tested 100%, because each location is written to, erased, and repeatedly exercised prior to encapsulation. Each device is also tested for AC performance to guarantee that the product will meet DC and AC specification limits after customer programming.

The CY27H010 is read by asserting both the  $\overline{CE}$  and the  $\overline{OE}$  inputs. The contents of the memory location selected by the address on inputs  $A_{16}-A_0$  will appear at the outputs  $O_7-O_0$ .

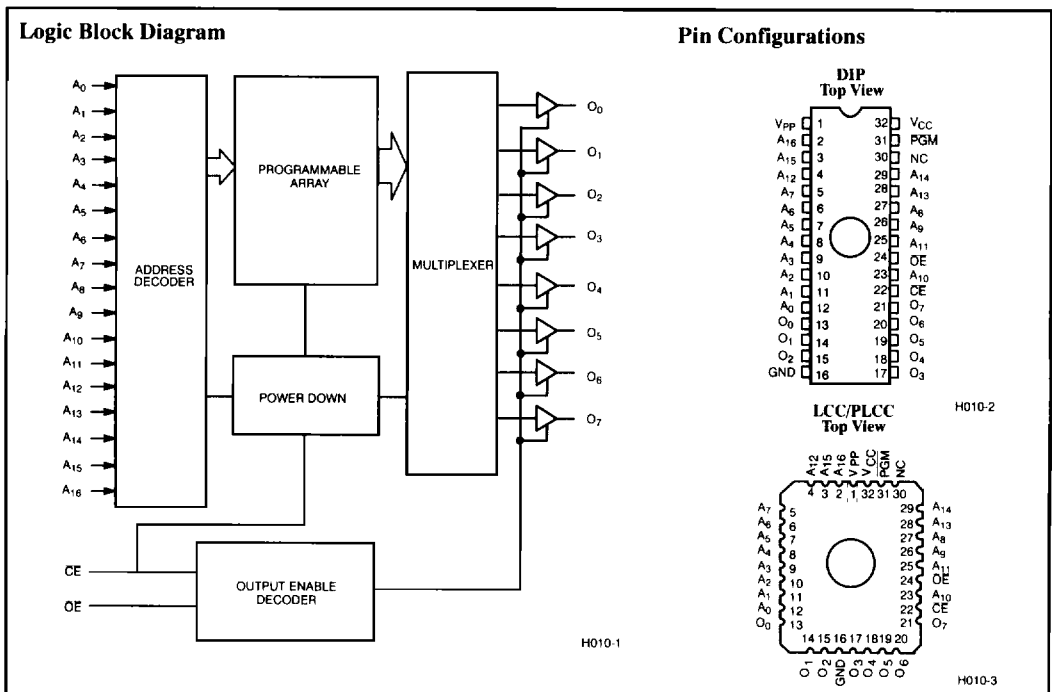

**Pin Configurations** (continued)

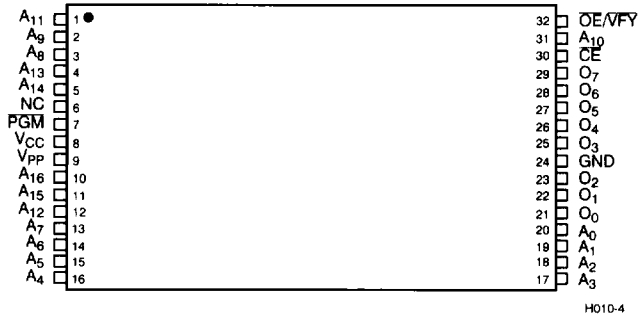
**TSOP  
Top View**

**4**
**Selection Guide**

		27H010-25	27H010-30	27H010-35	27H010-45	27H010-55	27H010-70
Maximum Access Time (ns)		25	30	35	45	55	70
CE Access Time (ns)	Com'l	30	35	40	45	55	70
	Mil			40	45	55	70
OE Access Time (ns)	Com'l	12	20	20	20	25	35
	Mil			20	20	25	35
I <sub>CC</sub> <sup>[1]</sup> (mA) Power Supply Current	Com'l	75	75	50	50	50	50
	Mil			85	60	60	60
I <sub>SB</sub> <sup>[2]</sup> (mA) Stand-by Current	Com'l	15	15	15	15	15	15
	Mil			25	25	25	25

**Maximum Ratings**

(Above which the useful life may be impaired. For user guidelines, not tested.)

- Storage Temperature ..... -65°C to +150°C
- Ambient Temperature with Power Applied ..... -55°C to +125°C
- Supply Voltage to Ground Potential ..... -0.5V to +7.0V
- DC Voltage Applied to Outputs in High Z State ..... -0.5V to +5.5V
- DC Input Voltage ..... -3.0V to +7.0V
- Transient Input Voltage ..... -3.0V for <20 ns
- DC Program Voltage ..... 13.0V

- UV Erase ..... 7258 Wsec/cm<sup>2</sup>
- Static Discharge Voltage (per MIL-STD-883, Method 3015) ..... >2001V
- Latch-Up Current ..... >200 mA

**Operating Range**

Range	Ambient Temperature	V <sub>CC</sub>
Commercial	0°C to +70°C	5V ± 10%
Industrial <sup>[3]</sup>	-40°C to +85°C	5V ± 10%
Military <sup>[4]</sup>	-55°C to +125°C	5V ± 10%

**Notes:**

1. V<sub>CC</sub> = Max., I<sub>OUT</sub> = 0 mA, f = 10 MHz.
2. V<sub>CC</sub> = Max., CE = V<sub>III</sub>.
3. Contact a Cypress representative for industrial temperature range specification.
4. T<sub>A</sub> is the "instant on" case temperature.

**Electrical Characteristics** Over the Operating Range [5, 6]

Parameter	Description	Test Conditions	27H010-25 27H010-30		27H010-35		27H010-45 27H010-55 27H010-70		Unit
			Min.	Max.	Min.	Max.	Min.	Max.	
V <sub>OH</sub>	Output HIGH Voltage	V <sub>CC</sub> = Min., I <sub>OH</sub> = -4.0 mA	2.4		2.4		2.4		V
V <sub>OL</sub>	Output LOW Voltage	V <sub>CC</sub> = Min., I <sub>OL</sub> = 12.0 mA		0.45		0.45		0.45	V
V <sub>IH</sub>	Input HIGH Level	Guaranteed Input Logical HIGH Voltage for All Inputs	2.0	V <sub>CC</sub> +0.5	2.0	V <sub>CC</sub> +0.5	2.0	V <sub>CC</sub> +0.5	V
V <sub>IL</sub>	Input LOW Level	Guaranteed Input Logical LOW Voltage for All Inputs		0.8		0.8		0.8	V
I <sub>IX</sub>	Input Leakage Current	GND ≤ V <sub>IN</sub> ≤ V <sub>CC</sub>	-10	+10	-10	+10	-10	+10	μA
I <sub>OZ</sub>	Output Leakage Current	GND ≤ V <sub>OUT</sub> ≤ V <sub>CC</sub> , Output Disable	-10	+10	-10	+10	-10	+10	μA
I <sub>CC</sub>	Power Supply Current	V <sub>CC</sub> = Max., I <sub>OUT</sub> = 0 mA, f = 10 MHz	Com'l	75		50		50	mA
			Mil				85		60
I <sub>SB</sub>	Stand-By Current	V <sub>CC</sub> = Max., C <sub>F</sub> = V <sub>IH</sub>	Com'l	15		15		15	mA
			Mil				25		25

**Capacitance**<sup>[6]</sup>

Parameter	Description	Test Conditions	Max.	Unit
C <sub>IN</sub>	Input Capacitance	T <sub>A</sub> = 25°C, f = 1 MHz, V <sub>CC</sub> = 5.0V	10	pF
C <sub>OUT</sub>	Output Capacitance		12	pF

**Notes:**

5. See the last page of the specification for Group A subgroup testing information.  
 6. See Introduction to CMOS PROMs in this Data Book for general information on testing.

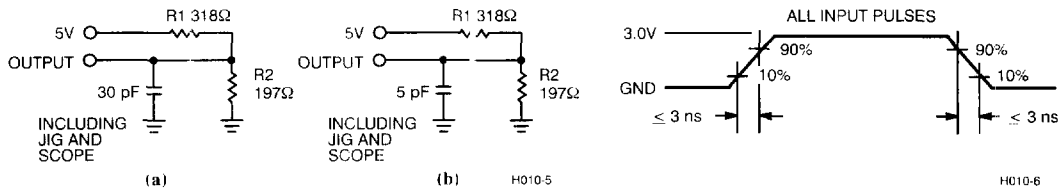
**AC Test Loads and Waveforms**

Equivalent to: THEVENIN EQUIVALENT

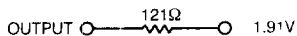

**Switching Characteristics** Over the Operating Range

Parameter	Description	27H010-25		27H010-30		27H010-35		27H010-45		27H010-55		27H010-70		Unit
		Min.	Max.	Min.	Max.	Min.	Max.	Min.	Max.	Min.	Max.	Min.	Max.	
$t_{AA}$	Address to Output Valid		25		30		35		45		55		70	ns
$t_{OE}$	$\overline{OE}$ Active to Output Valid		12		20		20		20		25		35	ns
$t_{HZOE}$	$\overline{OE}$ Inactive to High Z		12		20		20		20		25		35	ns
$t_{CE}$	$\overline{CE}$ Active to Output Valid		30		35		40		45		55		70	ns
$t_{HZCE}$	$\overline{CE}$ Inactive to High Z		12		20		20		20		25		35	ns
$t_{PU}$	$\overline{CE}$ Active to Power-Up	0		0		0		0		0		0		ns
$t_{PD}$	$\overline{CE}$ Inactive to Power-Down		30		35		40		50		60		75	ns
$t_{OH}$	Output Data Hold	0		0		0		0		0		0		ns

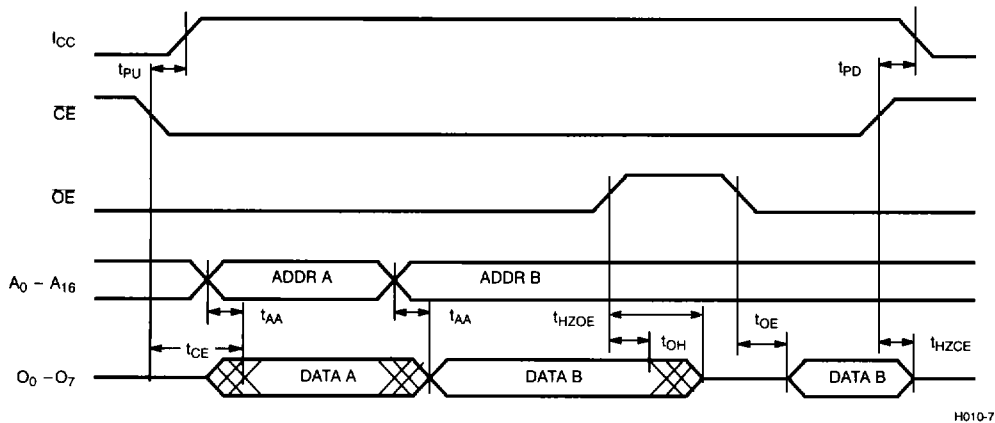
**Switching Waveform**

H010-7

### Erasure Characteristics

Wavelengths of light less than 4000 Å begin to erase the CY27H010 in the windowed package. For this reason, an opaque label should be placed over the window if the EPROM is exposed to sunlight or fluorescent lighting for extended periods of time.

The recommended dose of ultraviolet light for erasure is a wavelength of 2537 Å for a minimum dose (UV intensity multiplied by exposure time) of 25 Wsec/cm<sup>2</sup>. For an ultraviolet lamp with a 12 mW/cm<sup>2</sup> power rating, the exposure time would be approximately 35 minutes. The CY27H010 needs to be within 1 inch of the lamp

during erasure. Permanent damage may result if the EPROM is exposed to high-intensity UV light for an extended period of time. 7258 Wsec/cm<sup>2</sup> is the recommended maximum dosage.

### Programming Modes

Programming support is available from Cypress as well as from a number of third-party software vendors. For detailed programming information, including a listing of software packages, please see the PROM Programming Information located at the end of this section. Programming algorithms can be obtained from any Cypress representative.

**Table 1. Programming Electrical Characteristics**

Parameter	Description	Min.	Max.	Unit
V <sub>PP</sub>	Programming Power Supply	12.5	13	V
I <sub>PP</sub>	Programming Supply Current		50	mA
V <sub>IHP</sub>	Programming Input Voltage HIGH	3.0	V <sub>CC</sub>	V
V <sub>ILP</sub>	Programming Input Voltage LOW	-0.5	0.4	V
V <sub>CCP</sub>	Programming V <sub>CC</sub>	6.0	6.5	V

**Table 2. Mode Selection**

Mode	Pin Function <sup>[7]</sup>						
	CE	OE	PGM	V <sub>PP</sub>	A <sub>0</sub>	A <sub>9</sub>	Data
Read	V <sub>IL</sub>	V <sub>IL</sub>	X	V <sub>IH</sub>	A <sub>0</sub>	A <sub>9</sub>	O <sub>7</sub> - O <sub>0</sub>
Output Disable	V <sub>IL</sub>	V <sub>IH</sub>	X	V <sub>IH</sub>	A <sub>0</sub>	A <sub>9</sub>	High Z
Stand-by	V <sub>IH</sub>	X	X	V <sub>IH</sub>	X	X	High Z
Program	V <sub>ILP</sub>	V <sub>IHP</sub>	V <sub>ILP</sub>	V <sub>PP</sub>	A <sub>0</sub>	A <sub>9</sub>	D <sub>7</sub> - D <sub>0</sub>
Program Verify	V <sub>ILP</sub>	V <sub>ILP</sub>	V <sub>IHP</sub>	V <sub>PP</sub>	A <sub>0</sub>	A <sub>9</sub>	O <sub>7</sub> - O <sub>0</sub>
Program Inhibit	V <sub>ILP</sub>	V <sub>IHP</sub>	V <sub>IHP</sub>	V <sub>PP</sub>	A <sub>0</sub>	A <sub>9</sub>	High Z
Signature Read (MFG)	V <sub>IL</sub>	V <sub>IL</sub>	X	V <sub>IH</sub>	V <sub>IL</sub>	V <sub>HV</sub> <sup>[8]</sup>	34H
Signature Read (DEV)	V <sub>IL</sub>	V <sub>IL</sub>	X	V <sub>IH</sub>	V <sub>IH</sub>	V <sub>HV</sub> <sup>[8]</sup>	1DH

Note:

7. X can be V<sub>IL</sub> or V<sub>IH</sub>.

8. V<sub>HV</sub> = 12V ± 0.5V

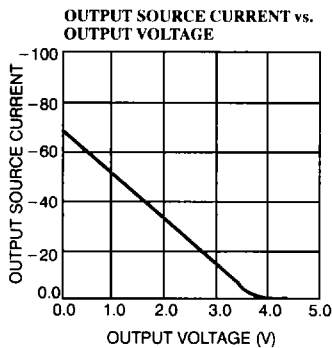
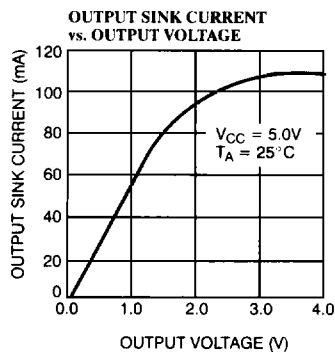
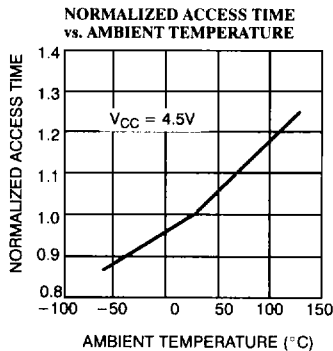
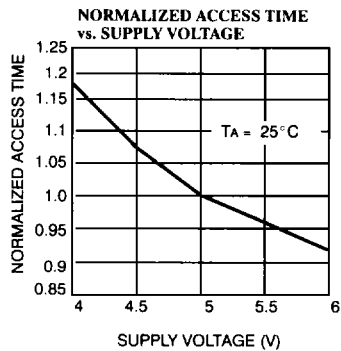
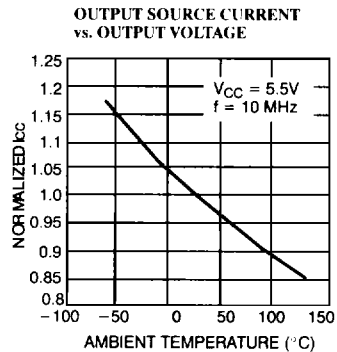
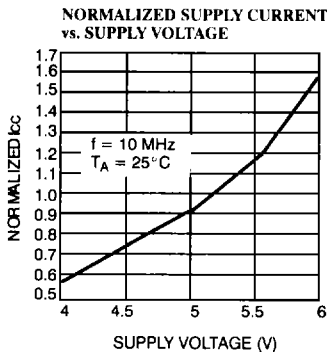
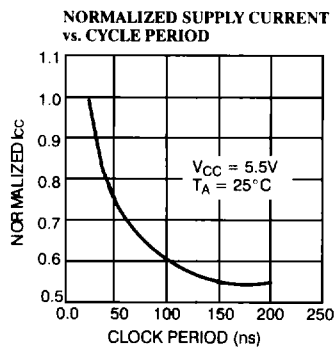
**Typical DC and AC Characteristics**

H010-8

**Ordering Information<sup>9)</sup>**

Speed (ns)	Ordering Code	Package Name	Package Type	Operating Range
25	CY27H010-25HC	H65	32-Pin Windowed Leaded Chip Carrier	Commercial
	CY27H010-25JC	J65	32-Lead Plastic Leaded Chip Carrier	
	CY27H010-25ZC	Z32	32-Lead Thin Small Outline Package	
30	CY27H010-30HC	H65	32-Pin Windowed Leaded Chip Carrier	Commercial
	CY27H010-30JC	J65	32-Lead Plastic Leaded Chip Carrier	
	CY27H010-30PC	P19	32-Lead (600-Mil) Molded DIP	
	CY27H010-30WC	W20	32-Lead (600-Mil) Windowed CerDIP	
	CY27H010-30ZC	Z32	32-Lead Thin Small Outline Package	
35	CY27H010-35HC	H65	32-Pin Windowed Leaded Chip Carrier	Commercial
	CY27H010-35JC	J65	32-Lead Plastic Leaded Chip Carrier	
	CY27H010-35PC	P19	32-Lead (600-Mil) Molded DIP	
	CY27H010-35WC	W20	32-Lead (600-Mil) Windowed CerDIP	
	CY27H010-35ZC	Z32	32-Lead Thin Small Outline Package	Military
	CY27H010-35HMB	H65	32-Pin Windowed Leaded Chip Carrier	
	CY27H010-35LMB	L55	32-Pin Rectangular Leadless Chip Carrier	
	CY27H010-35QMB	Q55	32-Pin Windowed Rectangular Leadless Chip Carrier	
45	CY27H010-45HC	H65	32-Pin Windowed Leaded Chip Carrier	Commercial
	CY27H010-45JC	J65	32-Lead Plastic Leaded Chip Carrier	
	CY27H010-45PC	P19	32-Lead (600-Mil) Molded DIP	
	CY27H010-45WC	W20	32-Lead (600-Mil) Windowed CerDIP	
	CY27H010-45ZC	Z32	32-Lead Thin Small Outline Package	
	CY27H010-45DMB	D20	32-Lead (600-Mil) CerDIP	Military
	CY27H010-45HMB	H65	32-Pin Windowed Leaded Chip Carrier	
	CY27H010-45LMB	L55	32-Pin Rectangular Leadless Chip Carrier	
	CY27H010-45QMB	Q55	32-Pin Windowed Rectangular Leadless Chip Carrier	
CY27H010-45WMB	W20	32-Lead (600-Mil) Windowed CerDIP		
55	CY27H010-55HC	H65	32-Pin Windowed Leaded Chip Carrier	Commercial
	CY27H010-55JC	J65	32-Lead Plastic Leaded Chip Carrier	
	CY27H010-55PC	P19	32-Lead (600-Mil) Molded DIP	
	CY27H010-55WC	W20	32-Lead (600-Mil) Windowed CerDIP	
	CY27H010-55ZC	Z32	32-Lead Thin Small Outline Package	
	CY27H010-55DMB	D20	32-Lead (600-Mil) CerDIP	Military
	CY27H010-55HMB	H65	32-Pin Windowed Leaded Chip Carrier	
	CY27H010-55LMB	L55	32-Pin Rectangular Leadless Chip Carrier	
	CY27H010-55QMB	Q55	32-Pin Windowed Rectangular Leadless Chip Carrier	
CY27H010-55WMB	W20	32-Lead (600-Mil) Windowed CerDIP		

**Notes:**

9. Most of the above products are available in industrial temperature range. Contact a Cypress representative for specifications and product availability.

**Ordering Information<sup>(9)</sup>** (continued)

Speed (ns)	Ordering Code	Package Name	Package Type	Operating Range
70	CY27H010-70HC	H65	32-Pin Windowed Leaded Chip Carrier	Commercial
	CY27H010-70JC	J65	32-Lead Plastic Leaded Chip Carrier	
	CY27H010-70PC	P19	32-Lead (600-Mil) Molded DIP	
	CY27H010-70WC	W20	32-Lead (600-Mil) Windowed CerDIP	
	CY27H010-70ZC	Z32	32-Lead Thin Small Outline Package	
	CY27H010-70DMB	D20	32-Lead (600-Mil) CerDIP	Military
	CY27H010-70HMB	H65	32-Pin Windowed Leaded Chip Carrier	
	CY27H010-70LMB	L55	32-Pin Rectangular Leadless Chip Carrier	
	CY27H010-70QMB	Q55	32-Pin Windowed Rectangular Leadless Chip Carrier	
	CY27H010-70WMB	W20	32-Lead (600-Mil) Windowed CerDIP	

**4**
**MILITARY SPECIFICATIONS**
**Group A Subgroup Testing**
**DC Characteristics**

Parameter	Subgroups
V <sub>OH</sub>	1, 2, 3
V <sub>OL</sub>	1, 2, 3
V <sub>IH</sub>	1, 2, 3
V <sub>IL</sub>	1, 2, 3
I <sub>I<sub>X</sub></sub>	1, 2, 3
I <sub>OZ</sub>	1, 2, 3
I <sub>CC</sub>	1, 2, 3
I <sub>SB</sub>	1, 2, 3

**Switching Characteristics**

Parameter	Subgroups
t <sub>AA</sub>	7, 8, 9, 10, 11
t <sub>OE</sub>	7, 8, 9, 10, 11
t <sub>CE</sub>	7, 8, 9, 10, 11

Document #: 38-00171-B